

Instruction Manual

**BL1.5 • BL3 • BL5
BL7 • BL10
BL15 • BL20**

Dosing Pumps

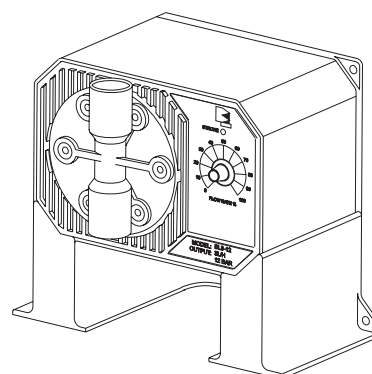

Dear Customer,
Thank you for choosing a Hanna product.
Please read this instruction manual carefully before using the pump.
If you need additional technical information, do not hesitate to e-mail us at **tech@hannainst.com**.
These instruments are in compliance with the CE directives.

WARRANTY

All Hanna Instruments **pumps are warranted for one year** against defects in workmanship and materials when used for their intended purpose and maintained according to instructions.

This warranty is limited to repair or replacement free of charge. Damages due to accident, misuse, tampering or lack of prescribed maintenance are not covered. If service is required, contact the dealer from whom you purchased the instrument. If under warranty, report the model number, date of purchase, serial number and the nature of the failure. If the repair is not covered by the warranty, you will be notified of the charges incurred. If the instrument is to be returned to Hanna Instruments, first obtain a Returned Goods Authorization Number from the Customer Service department and then send it with shipment costs prepaid. When shipping any instrument, make sure it is properly packaged for complete protection.

TABLE OF CONTENTS

Preliminary Examination	3
General Description	5
Flow Rate Chart	7
Functional Description	9
Specifications	10
Valve / Hose Assembly Diagram	11
Installation	12
Operational Guide	21
Troubleshooting Guide	23
Maintenance	25
Chemical Compatibility Guide	27
Accessories	29
CE Declaration of Conformity	31

PRELIMINARY EXAMINATION

Remove the pump from the packing material and examine it carefully to make sure that no damage has occurred during shipping. If there is any noticeable damage, notify your Dealer.

Each pump is supplied complete with:

- 7 m (23') LDPE suction and discharge tubing
- Instruction manual

Note: Save all packing material until you are sure that the pump functions correctly. Any defective item must be returned in the original packaging together with the supplied accessories.

READ ATTENTIVELY THE INSTRUCTIONS BEFORE INSTALLING OR OPERATING YOUR PUMP

The BL electronic dosing pumps are easy to use. We recommend, however, that you read the entire manual before using the pump. Familiarity with the features and controls of the unit will give you a better idea of the dosing potential and help reduce operator errors. Please operate the pump only as directed in the instruction manual. Follow all general safety guidelines during operation.

Remember: electrical devices are potentially hazardous. Check that the voltage of the installation matches the voltage indicated on the specification label on the back of the pump. Always be sure the pump is grounded.

Note: It is the responsibility of the user to install and ground the pump properly; it is highly recommended to install an external switch.

Always store chemicals in safe, out of reach places. Follow the directions for use with each chemical. Do not assume chemicals are the same because they look alike. Hanna Instruments cannot be held responsible for the misuse of chemicals or the pump.

Always wear protective clothing (gloves and safety glasses) when working near chemical dosing pumps. When pumping chemicals, make sure all tubes are securely attached to the fittings. It is recommended that tubing is shielded to prevent possible injury in case of rupture or accidental damage.

Avoid using a pipe wrench or pliers on plastic parts and connectors. These are best tightened with an open end or crescent wrench. Avoid overtightening these parts as this could cause damage to the seats and threads.

If a hose is used, it should be securely fastened to columns, walls, braces, etc. This will ensure that the hose connection will remain tight and leak free. Shield the hose from direct sunlight. Sunlight can cause an autocatalytic reaction with some chemicals and weaken the hose walls.

The arrow on the pump head indicates the direction of chemical flow and should always point upwards (vertically). Never position the pump horizontally with suction and discharge valves horizontal. Locate the pump in an area out of the reach of children and pets.

All pumps undergo stringent tests to ensure that they comply with their stated specifications and are calibrated at the maximum rated pressure.

GENERAL DESCRIPTION

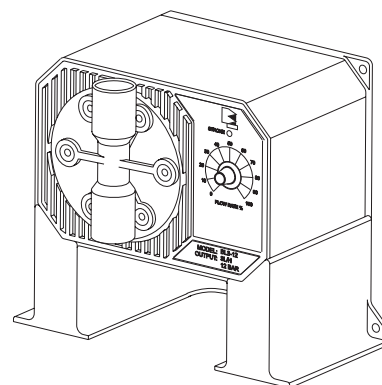

BlackStone pumps are equipped with a single control for pump output.

Flow range is continuously adjustable from 0 to 100% of the maximum capacity through a graded dial on the front of the pumps.

Seven models are available, each with a different dosing capacity:

BL 20	18.3 lph (4.8 gph) @ 0.5 bar (7.4 psi)
BL 15	15.2 lph (4.0 gph) @ 1 bar (14.5 psi)
BL 10	10.8 lph (2.9 gph) @ 3 bar (43.5 psi)
BL 7	7.6 lph (2.0 gph) @ 3 bar (43.5 psi)
BL 5	5.0 lph (1.3 gph) @ 7 bar (101.5 psi)
BL 3	2.9 lph (0.8 gph) @ 8 bar (116 psi)
BL 1.5	1.5 lph (0.4 gph) @ 13 bar (188.5 psi)

High quality materials

To provide the maximum protection for parts that are in contact with aggressive chemicals, diaphragms, hose connectors and pump heads are produced using materials as PVDF and PTFE.

The ball valves are constructed in glass. The body is made of fiber-reinforced polypropylene for strength and durability.

Reliability through simplicity

All BlackStone pumps use the positive displacement solenoid method of pumping. This method has fewer moving parts than a standard motor-driven pump, and does not have the mechanical failures associated with conventional pumps.

BlackStone's Positive Displacement design has several distinct advantages over other types of mechanical designs:

- It is more accurate. Each stroke of the piston is precisely the same as the stroke before it ... and the stroke after it.
- Positive displacement allows for easier self-priming.
- Pumping pressure is as high as 12 bar (176 psi). This allows you to install your pump in the widest variety of tank-to-tank and tank-to-in-line applications.
- High accuracy and repeatability. A wire-wound potentiometer and solid state electronics are combined to achieve greater precision and control.

Easy installation

Designed with mounting holes in the base as well as rear panel, BlackStone pumps can be installed on a wall as well as directly on top of tanks and drums.

There is no need for additional hardware. All the controls and pump assemblies are conveniently located on the front of the unit. If the operator must access the pump head or control panel for any reason, there is no need to dismount the unit.

FLOW RATE CHART

The following charts show the relationship between their flow rate and pressure.

An increase of pressure in the system decreases the flow rate.

BL1.5	
bar (psi)	lph (gph)
0.5 (7.4)	8.3 (2.20)
1 (14.7)	6.8 (1.80)
2 (29.4)	5.4 (1.43)
3 (44.1)	5.2 (1.38)
4 (58.8)	4.8 (1.27)
5 (73.5)	4.5 (1.19)
6 (88.2)	4.1 (1.08)
7 (102.9)	3.2 (0.85)
8 (117.6)	2.9 (0.77)
9 (132.3)	2.1 (0.56)
10 (147)	1.8 (0.48)
11 (161.7)	1.7 (0.45)
12 (176.4)	1.6 (0.42)

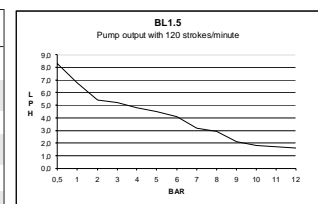

BL3	
bar (psi)	lph (gph)
0.5 (7.4)	15.8 (4.18)
1 (14.7)	12.2 (3.23)
2 (29.4)	9.3 (2.46)
3 (44.1)	7.9 (2.09)
4 (58.8)	6.5 (1.71)
5 (73.5)	5.0 (1.32)
6 (88.2)	4.0 (1.06)
7 (102.9)	3.3 (0.87)
8 (117.6)	2.9 (0.77)
9 (132.3)	2.5 (0.66)
10 (147)	2.2 (0.58)
11 (161.7)	1.9 (0.50)
12 (176.4)	1.5 (0.40)

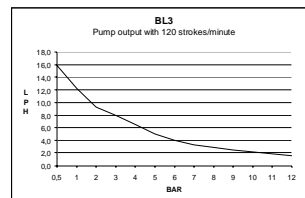

BL5	
bar (psi)	lph (gph)
0.5 (7.4)	15.8 (4.18)
1 (14.7)	12.2 (3.23)
2 (29.4)	10.8 (2.86)
3 (44.1)	9.3 (2.46)
4 (58.8)	7.9 (2.09)
5 (73.5)	6.5 (1.72)
6 (88.2)	5.8 (1.53)
7 (102.9)	5.0 (1.32)
8 (117.6)	4.3 (1.14)
9 (132.3)	4.0 (1.06)
10 (147)	3.6 (0.95)

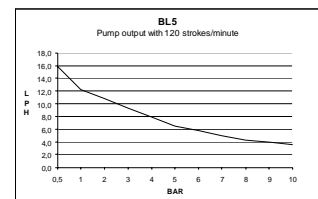

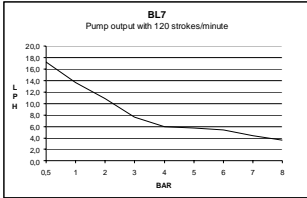

BL7	
bar (psi)	lph (gph)
0.5 (7.4)	17.2 (4.55)
1 (14.7)	13.6 (3.60)
2 (29.4)	10.8 (2.86)
3 (44.1)	7.6 (2.01)
4 (58.8)	6.0 (1.59)
5 (73.5)	5.7 (1.51)
6 (88.2)	5.4 (1.43)
7 (102.9)	4.4 (1.16)
8 (117.6)	3.6 (0.95)

BL10	
bar (psi)	lph (gph)
0.5 (7.4)	18.3 (4.84)
1 (14.7)	15.2 (4.02)
2 (29.4)	13.6 (3.60)
3 (44.1)	10.8 (2.86)
4 (58.8)	9.4 (2.49)

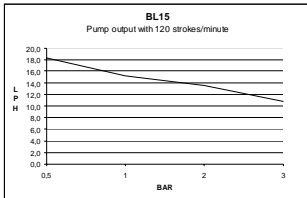
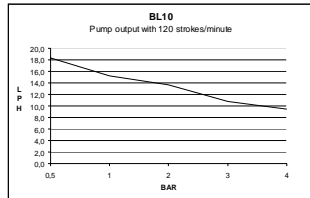

BL15	
bar (psi)	lph (gph)
0.5 (7.4)	18.3 (4.84)
1 (14.7)	15.2 (4.02)
2 (29.4)	13.6 (3.60)
3 (44.1)	10.8 (2.86)

BL20	
bar (psi)	lph (gph)
0.5 (7.4)	18.3 (4.84)
1 (14.7)	15.2 (4.02)
2 (29.4)	13.6 (3.60)

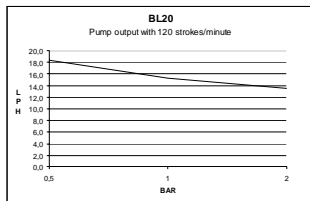

8

FUNCTIONAL DESCRIPTION

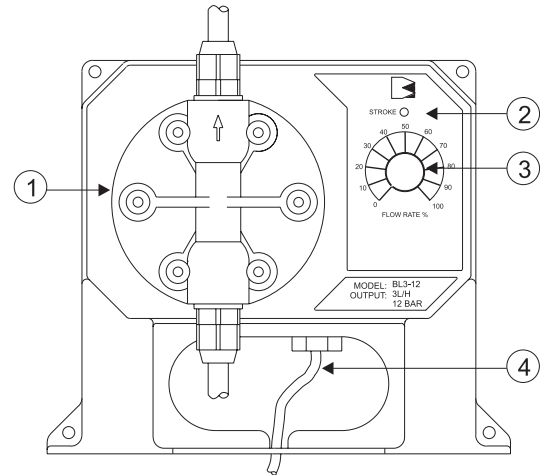

1. Pumphead
2. Stroke LED
3. Flow Rate % Knob
4. Power Cord

MECHANICAL DIMENSIONS

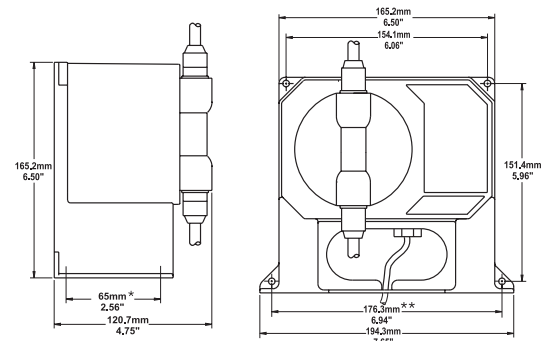

9

SPECIFICATIONS

MAX FLOW RATE

BL1.5	1.5 lph (0.4 gph) @ 13 bar (188.5 psi)
BL3	2.9 lph (0.8 gph) @ 8 bar (116 psi)
BL 5	5.0 lph (1.3 gph) @ 7 bar (101.5 psi)
BL7	7.6 lph (2.0 gph) @ 3 bar (43.5 psi)
BL10	10.8 lph (2.9 gph) @ 3 bar (43.5 psi)
BL15	15.2 lph (4.0 gph) @ 1 bar (14.5 psi)
BL20	18.3 lph (4.8 gph) @ 0.5 bar (7.4 psi)

Adjustable from 0 to 100% of maximum pump capacity

MATERIAL

PUMP CASING	fiber-reinforced polypropylene
VALVES	glass balls + O-rings in FPM/FKM
PUMPHEAD	PVDF
DIAPHRAGM	PTFE
TUBING	polyethylene

SELF PRIMING Max. height: 1.5 m (5')

POWER SUPPLY

BL...-1	100/115 Vac; 50/60 Hz
BL...-2	220/240 Vac; 50/60 Hz

MAX POWER CONSUMPTION 200 W

PROTECTION IP65

ENVIRONMENT 0 to 50°C (32 to 122°F)
95% RH max

DIMENSIONS 194 x 165 x 121 mm (WxHxD)
(7.6 x 6.5 x 4.8")

WEIGHT 3 kg (6.6 lb.)

VALVE / HOSE ASSEMBLY DIAGRAM

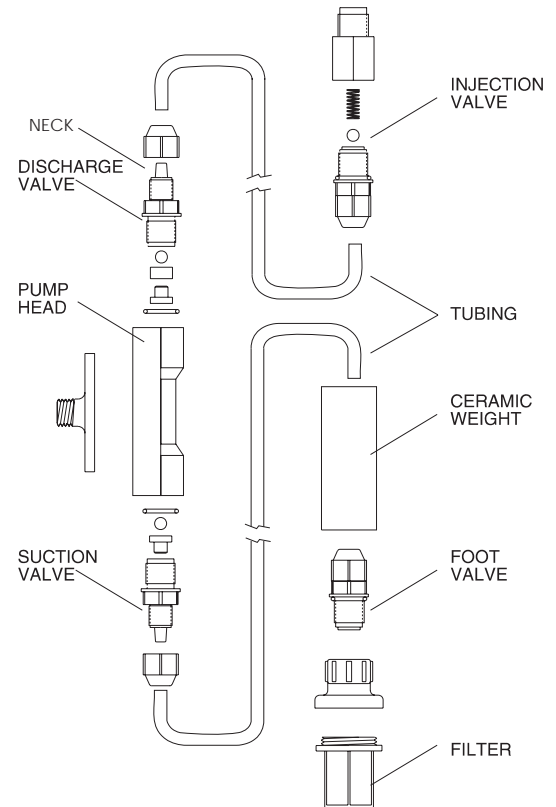

INSTALLATION

Materials Needed

- LDPE hose (7 meter / 22 feet) (**included**) or other type of tubing (PTFE, for example) more suitable for a specific application (optional)

Optional Accessories

- 4 each, ceramic weights (**HI 721008**)



- 1 each, foot valve assembly (**HI 721005**)

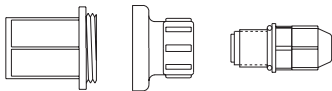

- 1 each, injection valve assembly (**HI 721004**)



Location

A suitable location should:

- be near to a power source
- be conveniently close to the injection point
- allow easy access to the flow rate control and pipe or hose connections
- be no more than 1.5 meters (5 feet) above the operating position of the suction valve assembly.

Dimensions for Installation

BlackStone pumps are designed for permanent installation.

The pump can be mounted directly on a wall or tank.

Power Requirements

BlackStone pumps are designed to operate to specifications within the following voltage ranges:

100 - 130 Volts for -1 models

200 - 240 Volts for -2 models

To ensure maximum performance, check the voltage at the point of supply to verify that it is sufficient. It is recommended that you install a 1 Amp circuit breaker between the pump and the power supply. This will give additional protection to the internal circuit and provide a convenient way to disconnect the power supply prior to servicing the pump, if needed.

Injection Point

- Choose an injection point that allows you to mount the injection valve assembly vertically.
- The spring in the injection valve assembly (**HI 721004**) adds approximately 1.5 bar of back pressure. If pumping into a high back pressure, the spring should be removed.

Other Considerations

- If you are mounting the system to a wall, column, etc., be sure it is strong enough to support the weight of the entire system.
- The ambient temperature of the pump, when in operation, should be between 0 and 50°C (32 to 122°F) and should be protected from direct exposure to outdoor elements (direct sunlight, rain, extreme temperatures, high humidity, etc.).
- Generally speaking, the shorter the suction distance, the more efficient the pump operates.

- The pump should be placed in a conventional location that will allow easy access to the control and connections. It should be placed so that regular visual inspections of the connections and hoses are facilitated.

Vertical Surface Mounting

Once you have selected the best installation site, simply screw or bolt the unit into a wall or mounting panel above the chemical feed tank.

The 4 mounting screw holes on the pump will accommodate up to a 5 mm (3/16") screw or bolt (remember to use heavy screws or bolts to secure the system).

Be sure you do not over tighten and cause excessive stress on the mounting holes.

Electrical Connections

Note: All cables must be according to local electrical codes.

For safety of the users, the pump has to be grounded.

The pump should be connected to a single phase power source.

Color coding for wires:

Blue - Live

Brown - Neutral

Yellow/Green - Ground (earth)

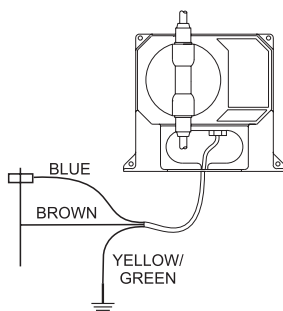

It is recommended that the system be connected to a power line/leg equipped with a circuit breaker of 1 Amp.

Permanent Connection using 3/8" PVC pipe

All piping for the pump feed and discharge should be plumbed to the location of the pump.

The threads on both valve assemblies allow the use of standard 3/8" (European) pipe fittings for permanent pipe connections.

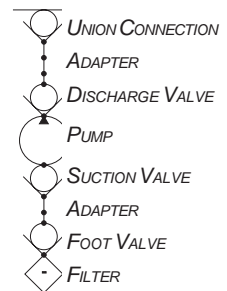
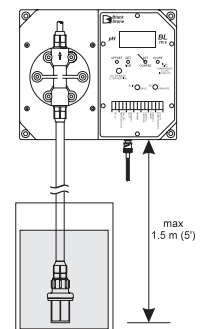

Diagram for Rigid Pipe Hose permanent pipe connections.

The foot valve assembly (HI 721005) should always hang vertically and not lay horizontal on the bottom of the tank or drum.

A vertical assembly will ensure that the valve is positioned properly and prevent loss of prime.



For the U.S. standard installations, use PVC adapters to connect the suction and discharge valves to the PVC pipe.

Hose Connections

- Cut a long enough section of the hose to reach the suction valve of the pumphead from

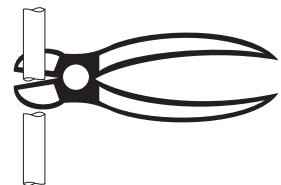

the feed tank. Allow some slack in the hose and be sure it is not kinked or twisted.

- Slip a hose connector onto the hose over the head valve and up to the bottom of the threads ensuring it is fully seated.

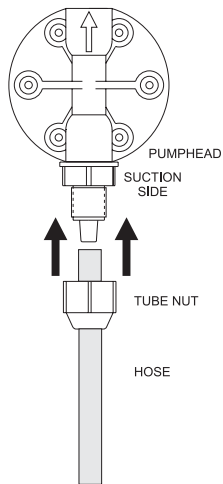

- Slide the connector up to the threads and tighten to form a seal.

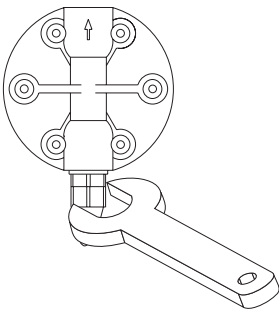

- Slip the ceramic weight (HI 721008) and a connector over the other end of the hose.

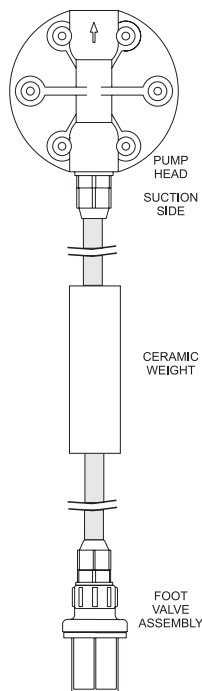

- Attach the foot valve assembly (HI 721005) to the hose and slide the connector up to the threads and tighten to form a seal.

- Repeat the same installation procedure for the hose connections on the discharge end with the injection assembly (HI 721004).

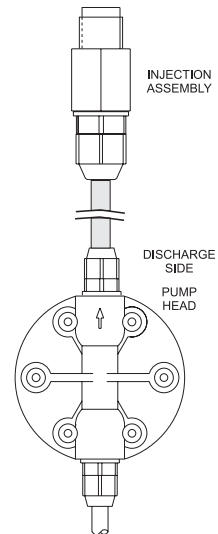
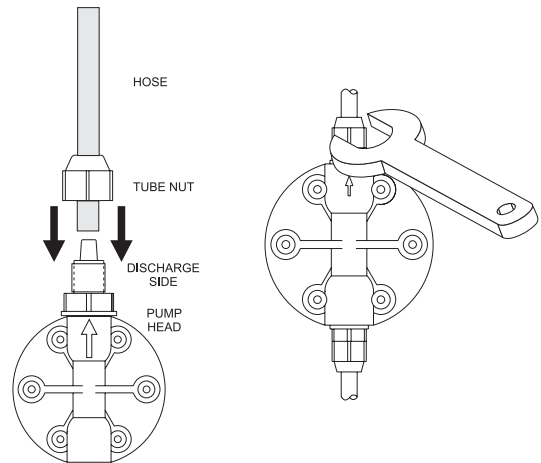

- Secure the hose so that its movement is minimized when the pump is operating. Excessive hose movement could cause the connectors to loosen and result in leakage.

Assembling the Hose to the Valve

The end of the valve is specially tapered to form a leak free seal when the hose is properly installed.

Be sure to seat the hose completely so that there is no gap. Push the hose until it covers the end of the valve completely.

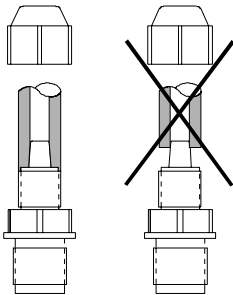

Suction and Discharge Valves

The suction and discharge valves located on the pumphead should not be interchanged as they are different internally. The discharge valve is fitted with a valve guide and will not function properly if used on the suction side.

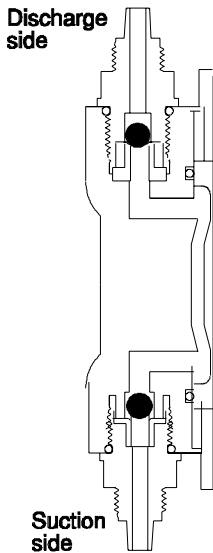

EXAMPLE OF TYPICAL INSTALLATIONS

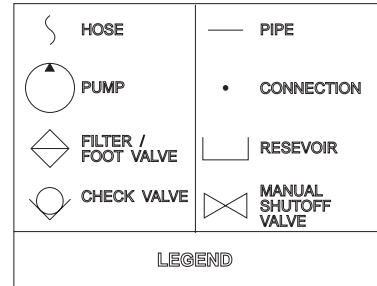

Flooded Suction Installation

Suggested Installation for consistent output when using a low stroke rate. Also suggested for highly viscous chemicals.

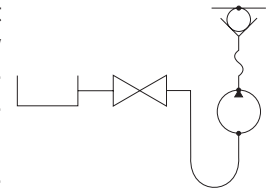

A slight suction pressure avoids self-priming problems, especially with high viscosity liquids.

Suction Lift Installation

Suggested installation for most in-line applications with nominal output and pressures.

The maximum self-priming height is 1.5 m (5 ft.). It is advisable to install a level controller in order to stop the pump when feed tank liquid level is low.

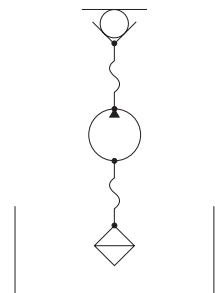

Uphill Installation

Suggested installation whenever the supply is located higher than the discharge point; typically a waste water application.

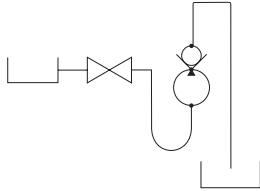

It is important to install the Injection valve to prevent siphoning.

Downhill Installation

Suggested installation when pumping from one container to another, each at different levels and with only nominal pressure.

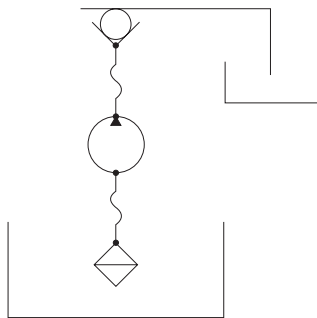

OPERATIONAL GUIDE

START-UP

At start-up, purge all chemical gases and air from the suction tubing, valves and pump head. Start the pump.

When all the air or gas is vented, the solution being metered will appear in the output line.

Note: Only when operating under pressure, the pump must be started unloaded.

An external Flow Rate Control (potentiometer) on the face of the pump allows to adjust the flow up to 100% of the pump's rated capacity.

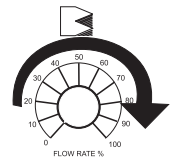

A LED indicator will light up each time a stroke begins.

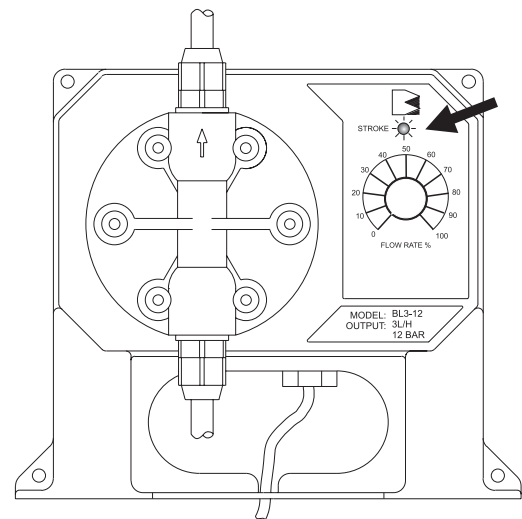

Operating Pressure and Back Pressure

Operating pressure is a combination of back pressure plus all of the other resistances to flow present in your system.

BlackStone Pumps are designed to dose their rated output at the operating (*rated*) pressure. Therefore, *rated* pressure of the pump you install should be close to operating pressure present in the system.

Too little back pressure can cause the pump to overdose.

To prevent this from happening on a low back pressure installation, a spring has been added to the discharge/anti-siphon valve assembly (**HI 721004**).

When pumping into a high back pressure, the spring should be removed.

Actual Flow Rate

The actual flow rate depends upon the operating pressure which includes resistance at the injection fittings, hose and piping, the chemical viscosity and suction lift. The Flow Rate Control adjusts the flow up to 100% of the *rated* output. Less back pressure will increase the output, more will decrease it. To determine the correct setting for your application, use the following procedure.

1. Be sure that the pump is primed and that the output connections are completed at the injection point.
2. Place the foot valve assembly (**HI 721005**) in a graduated container with 500 mL of the solution to be dosed.
3. Switch the pump from OFF to the 100% setting and run until the system has been fully reprimed. Switch OFF and refill the container to the 500 mL level.

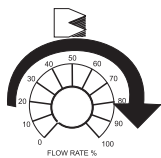
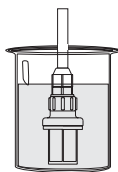

4. Switch the pump ON to the estimated setting and run for a specific amount of time (e.g. 1 minute). Count the number of strokes, length of time, and volume pumped.

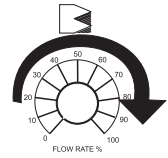

Note: It is suggested that you run the test for as long as possible to maximize the accuracy.

For example, if at the maximum setting of 100% you find you pumped 200 mL in one minute, your hourly output would be 12 liters/hour (200 mL x 60 min. = 12000 mL/hr). If your application called for 9 liters/hour, turn the Flow Rate Control to 7 (9/12). Run the test again to verify the results.

TROUBLESHOOTING GUIDE

Electrical

The pump does not operate when turned ON:

- Check the power supply and connections. Voltage should be between 100 - 130 Vac for -1 models and between 200 - 240 Vac for -2 models.
- Check wiring color scheme. See Installation section or call for technical assistance.

Liquid

The pump operates but does not prime:

- Check for a clogged or loose filter on the suction valve assembly. Retighten if necessary.
- Check to see if the pump is too high above the foot valve assembly (**HI 721005**) in the feed tank. This vertical distance should not

exceed 1.5 meters (5 feet). Either lower the pump or raise the feed tank.

- Check the pumphead, suction and discharge valves for blockage.

Pump flow rate is reduced:

- Check the pumphead, discharge and injection valve assembly for any clogging. Clean and reassemble.
- Check for any additional back pressure created since the last flow rate was conducted.
- Check for any changes in the viscosity of the chemicals being used. Increase the % flow by adjusting the Flow Rate control to a higher setting and run a Flow Rate test.
- Be sure that valves have been properly installed in the pumphead.

Leakage at the connections:

- Be sure that the hose is fully seated and hose connectors are tight.
- Be sure that valves are tight and O-rings are in place.

Leakage around the pumphead:

- Be sure that the valves are tight and O-rings are in place and the head screws (hex bolts) are tight.

MAINTENANCE

Your BlackStone Pump is designed to give you years of trouble-free service. Maintenance should be the preventative type, that is, periodic cleaning and inspecting for any damage or leakage.

Cleaning the Suction, Discharge and Injection Valves

Remove the valves from the pumphead, the injection fitting and the feed.

Keep the suction and discharge valves separated as they are not interchangeable.

Disassemble each valve and clean it with a neutral liquid. Inspect the PVDF springs.

After cleaning the glass balls, inspect them for any excessive wear due to abrasion from the chemical. Replace if necessary with parts from **HI 721102**, **HI 721103**, **HI 721104** and **HI 721105**.

When reinstalling the valves into the pumphead, tighten by hand first and then with a wrench $\frac{1}{4}$ to $\frac{1}{2}$ turn.

Inspecting the hose (if used as supplied with the pump)

Inspect to see if the hose has worn out or weakened due to the chemicals. Pay particular attention for any signs of abrasion or discoloration. Also check the connectors to ensure they are tight.

Replace if necessary with parts from **HI 720032**.

Cleaning the Pumphead

The pumphead should be cleaned at regular intervals and at least once a year. Remove the deposits that form in the cavities with a solution that is neutral to the chemical the pump has been dosing. Inspect the head for any cracks or worn areas.

Replace if necessary with parts from the pumphead spare part **HI 721106** (for BL7, BL10, BL15 and BL20) or **HI 721107** (for BL1.5, BL3 and BL5).

SCHEDULED MAINTENANCE

After 50 hours

Tight the pumphead screws with a torque force of 2.5 Nm (22" lbf).

After 12 months

It is recommended to replace **HI 721102**, **HI 721103** (suction and discharge valves assemblies) as well as the O-rings. The LDPE hose can also deteriorate over time and, for safety reasons, should also be changed with **HI 720032**.

After 24 months

It is recommended to replace **HI 721102**, **HI 721103**, **HI 720032** and **HI 721106** (for BL7, BL10, BL15 and BL20) or **HI 721107** (for BL1.5, BL3 and BL5).

CHEMICAL COMPATIBILITY GUIDE

Partial Listing of Chemicals that can be used with BlackStone Pumps

(Rated for 45°C. For higher temperatures consult your dealer or nearest Hanna Service Center)

Adipic Acid	Castor Oil
Alcohol Amyl	Caustic Soda
Alcohol, Diacetone	Chloral Hydrate
Alcohol, Isopropyl	Chromic Acid 50%
Alcohol, Methyl	Citric Acid
Aluminium, Ammonium Sulfate	Copper Chloride
Aluminium Chloride	Copper Cyanide
Aluminium Sulfate	Copper Nitrate
Alums	Copper Sulfate
Ammonium Carbonate	Corn Oil
Ammonium Chloride	Cottonseed Oil
Ammonium Fluoride	Cresylic Acid
Ammonium Hydroxide	Crude Oil
Ammonium Nitrate	Dextrose
Ammonium Phosphate	Detergents (general)
Ammonium Sulfate	Diesel Fuel
Aqua Ammonia	Diethyl Phthalate
Arsenic Acid	Disodium Phosphate
Barium Carbonate	Ethanol (1-95%)
Barium Chloride	Ethylene Dichloride
Barium Hydroxide	Ethylene Glycol
Barium Sulfate	Fatty Acids
Beer	Ferric Chloride
Beet Sugar Liquors	Ferric Nitrate
Bismuth Carbonate	Ferric Sulfate
Black Liquor	Ferrous Chloride
Bleach	Ferrous Sulfate
Borax	Fluoboric Acid
Boric Acid	Fluosilicic Acid
Bromic Acid	Formaldehyde
Butyric Acid	Fruit Juice Pulp
Calcium Bisulfite	Fuel Oil
Calcium Carbonate	Gallic Acid
Calcium Chlorate	Gasoline, Refined
Calcium Chloride	Glucose
Calcium Hydroxide	Glycerine or Glycerol
Calcium	Glycolic Acid 30%
Hypochlorite	Hexane
Calcium Nitrate	Hydrazine
Calcium Sulfate	Hydrobromic Acid 20%
Carbonic Acid	Hydrochloric Acid (Concentrated)

Hydrochloric Acid (Diluted)	Propyl Alcohol
Hydrofluoric Acid 60%	Propylene Dichloride
Hydrogen Sulfide Aqueous Solution	Sea Water
Hypochlorous Acid	Silver Nitrate
Kerosene	Silver Plating Solutions
Lactic Acid	Soaps
Lard Oil	Sodium Acetate
Lauric Acid	Sodium Bicarbonate
Lead Acetate	Sodium Bisulfate
Linoleic Acid	Sodium Bisulfite
Linseed Oil	Sodium Borate
Lithium Salts	Sodium Chlorate
Magnesium Carbonate	Sodium Chloride
Magnesium Chloride	Sodium Cyanide
Magnesium Hydroxide	Sodium Fluoride
Magnesium Nitrate	Sodium Nitrate
Magnesium Oxide	Hexametaphosphate
Magnesium Sulfate	Sodium Hydroxide 50%
Maleic Acid	Sodium Hypochlorite 18%
Malic Acid	Sodium Metaphosphate
Mercuric Chloride	Sodium Nitrate
Methanol	Sodium Peroxide
Methyl Sulfate	Sodium Phosphate
Milk	Sodium Silicate
Mineral Oils	Sodium Sulfate
Naptha Petroleum	Sodium Sulfide
Nickel Chloride	Sodium Sulfite
Nickel Sulfate	Sodium Thiosulfate
Nitric Acid 50%	Sour Crude Oil
Oils and Fats	Stannic Chloride
Oleic Acid	Stannous Chloride
Olive Oil	Stearic Acid
Oxalic Acid	Sulfur
Palmitric Acid	Sulfuric Acid Concentration
Perchloric Acid 70%	Sulfurous Acid
Perchloroethylene	Tannic Acid
Petroleum Oils (sour)	Tanning Liquors
Phenol	Tartaric Acid
Phosphoric Acid	Tetrachlorethane
Photographic Solutions	Tetraethyl Lead
Plating Solutions	Tetralin
Potassium Carbonate	Tin Salts
Potassium Bromide	Vegetable Oils
Potassium Chlorate	Vinegar
Potassium Chloride	Water Acid, Mine
Potassium Cyanide	Water, Fresh
Potassium Ferrocyanide	Water, Distilled
Potassium Hydroxide	Water, Salt
Potassium Nitrate	Whiskey
Potassium Permanganate 10%	Wines
Potassium Phosphate	Zinc Chloride
Potassium Sulfate	Zinc Sulfate

ACCESSORIES

SPARE PARTS

HI721102 Discharge Valve
(Glass Ball, Valve O-Ring, Hose Connector)

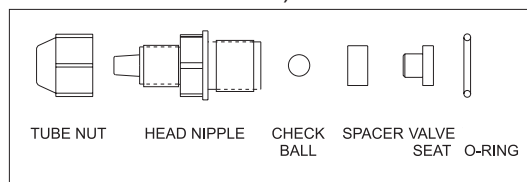

HI721103 Suction Valve (Glass Ball, Valve O-Ring, Hose Connector)

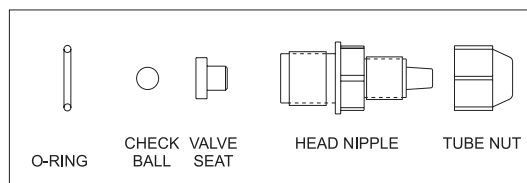

HI721003 10 x Glass Balls
10 x Valve O-Rings

HI 721004 Injection Valve Assembly

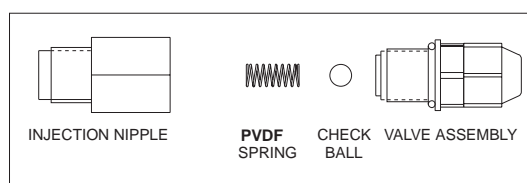

HI721005 Foot Valve Assembly

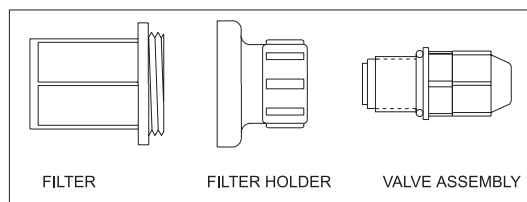

HI721006 PVDF Springs, 4 pcs

HI720032 LDPE Hose - 100 m (330')

HI 721008 Ceramic Weights, 4 pcs

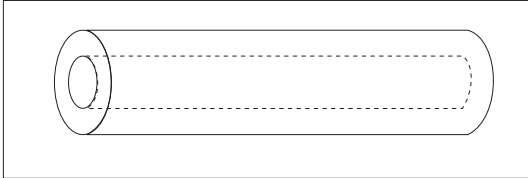

HI 721101 Pumphead, O-Ring, 6 screws and washers

HI 721106 (for BL7, BL10, BL15 and BL20)
Pumphead
Large PTFE Diaphragm
Aluminum Piston
Aluminum Disk

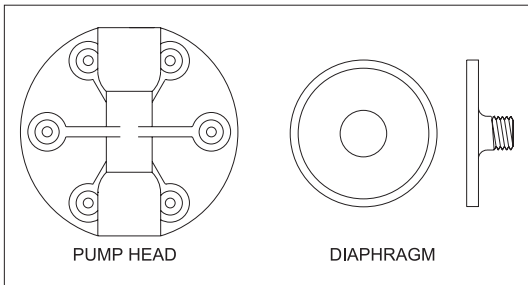

HI 721107 (for BL1.5, BL3 and BL5)
Pump-head
Small PTFE Diaphragm
Aluminum Piston

OTHER ACCESSORIES

HI 731326 Calibration screwdriver (20 pcs)

CE DECLARATION OF CONFORMITY

HANNA
instruments



DECLARATION OF CONFORMITY

We

Hanna Instruments Italia Srl
via E.Fermi, 10
35030 Sarmeola di Rubano - PD
ITALY

herewith certify that the dosing pumps

BL 1.5 BL 3 BL 5 BL 7 BL 10
BL15 BL 20 BL 7913 BL 7914

have been tested and found to be in compliance with EMC Directive 89/336/EEC and Low Voltage Directive 73/23/EEC according to the following applicable normative:

EN 50082-1: Electromagnetic Compatibility - Generic Immunity Standard
IEC 801-2 Electrostatic Discharge
IEC 801-3 RF Radiated
IEC 801-4 Fast Transient

EN 50081-1: Electromagnetic Compatibility - Generic Emission Standard
EN 55011 Radiated, Class B

EN61010-1: Safety requirements for electrical equipment for measurement, control and laboratory use

Date of Issue: 2-12-1998

P. Cesa - Technical Director
On behalf of
Hanna Instruments S.r.l.

Recommendations for Users

Before using these products, make sure that they are entirely suitable for the environment in which they are used.

Operation of these instruments in residential area could cause unacceptable interferences to radio and TV equipments, requiring the operator to take all necessary steps to correct interferences.

Any variation introduced by the user to the supplied equipment may degrade the instruments' EMC performance.

Hanna Instruments reserves the right to modify the design, construction and appearance of its products without advance notice.

SALES AND TECHNICAL SERVICE CONTACTS

Australia:

Tel. (03) 9769.0666 • Fax (03) 9769.0699

China:

Tel. (10) 88570068 • Fax (10) 88570060

Egypt:

Tel. & Fax (02) 2758.683

Germany:

Tel. (07851) 9129-0 • Fax (07851) 9129-99

Greece:

Tel. (210) 823.5192 • Fax (210) 884.0210

Indonesia:

Tel. (21) 4584.2941 • Fax (21) 4584.2942

Japan:

Tel. (03) 3258.9565 • Fax (03) 3258.9567

Korea:

Tel. (02) 2278.5147 • Fax (02) 2264.1729

Malaysia:

Tel. (603) 5638.9940 • Fax (603) 5638.9829

Singapore:

Tel. 6296.7118 • Fax 6291.6906

South Africa:

Tel. (011) 615.6076 • Fax (011) 615.8582

Taiwan:

Tel. 886.2.2739.3014 • Fax 886.2.2739.2983

Thailand:

Tel. 66.2619.0708 • Fax 66.2619.0061

United Kingdom:

Tel. (01525) 850.855 • Fax (01525) 853.668

USA:

Tel. (401) 765.7500 • Fax (401) 765.7575

MANBLR2
11/05

For e-mail contacts and complete list of Sales and Technical offices, please see www.hannainst.com